

Tous droits strictement réservés. Reproduction ou communication a des tiers interdite sous quelque forme que ce soit sans autorisation écrite du propriétaire. Propriété de c FCI. Droits de reproduction FCI.

All rights strictly reserved. Reproduction or issue to third parties in any form whatever is not permitted without written authority from the proprietor. Property of FCI. Copyright FCI.

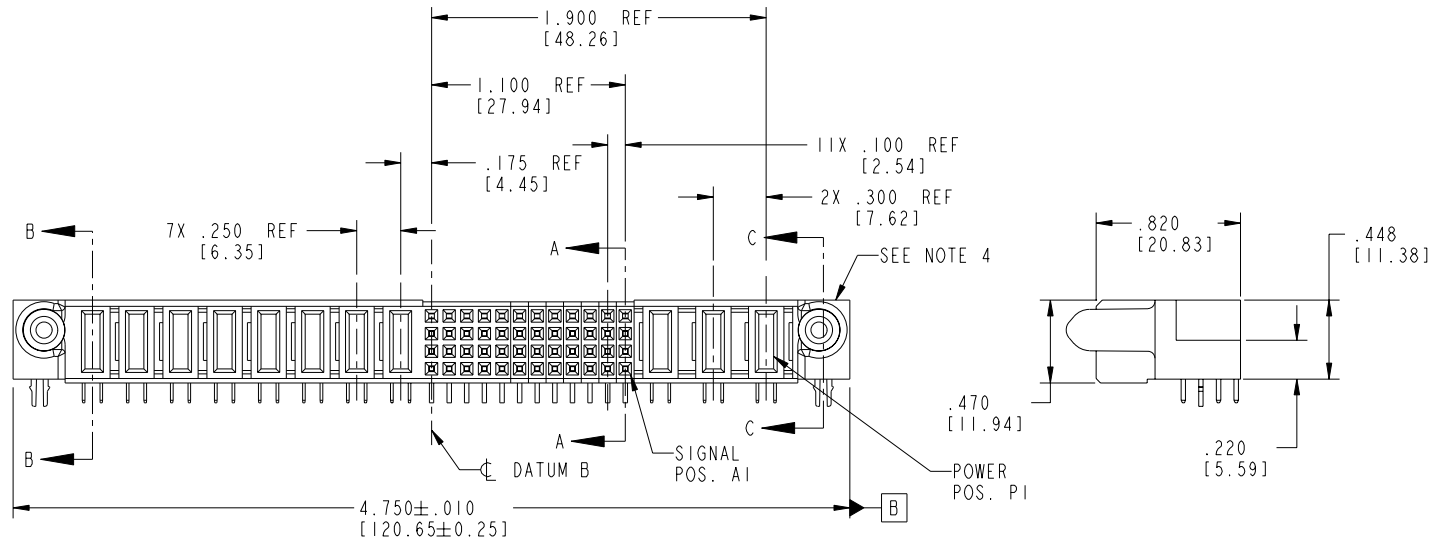
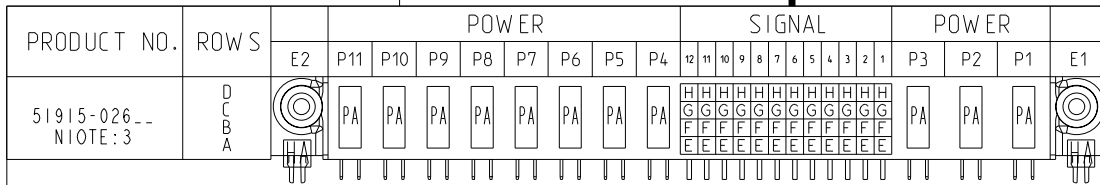

CODE	DIM "M" MATING LENGTH	CONTACT TYPE
E	N/A [N/A]	SIGNAL
F	N/A [N/A]	SIGNAL
G	N/A [N/A]	SIGNAL
H	N/A [N/A]	SIGNAL
PA	.042 [1.07]	POWER
HA	N/A [N/A]	HOLD-DOWN

mat'l code		SEE NOTE 2		tolerances unless otherwise specified		CUSTOMER	
ltr	ecn no.	dr	date	linear	projection	COPY	
A	V03-0530	TAB	05/09/03	.XX±.01/0.X±0.3	⊕	www.fciconnect.com	
B	V03-0715	MEM	6/27/03	.XXX±.005/0.XX±0.13	⊕	title 3ACP + 48S + 8P	
C	DG05-0365	CS	09/28/05	.XXX±.0020/0.XX±0.051	⊕	R/A SOLDER RECEPTACLE	
				angles	INCH/MM	product family	PwrBlade
				dr	1:1	size	code
				enrg		dwg no	213
				chr		51915-026	sheet
				appd			1 of 4
sheet index	revision	C	C	C	C		
	sheet	1	2	3	4		

sheet index		revision		C		C		C		C	
		1	2	3	4						

cage code 22526 4

Tous droits strictement réservés. Reproduction ou communication a des tiers interdite sous quelque forme que ce soit sans autorisation écrite du propriétaire. Propriété de c FCI. Droits de reproduction FCI.

All rights strictly reserved. Reproduction or issue to third parties in any form whatever is not permitted without written authority from the proprietor. Property of FCI. Copyright FCI.

PRODUCT NUMBER
51915-026__
NOTE: 3

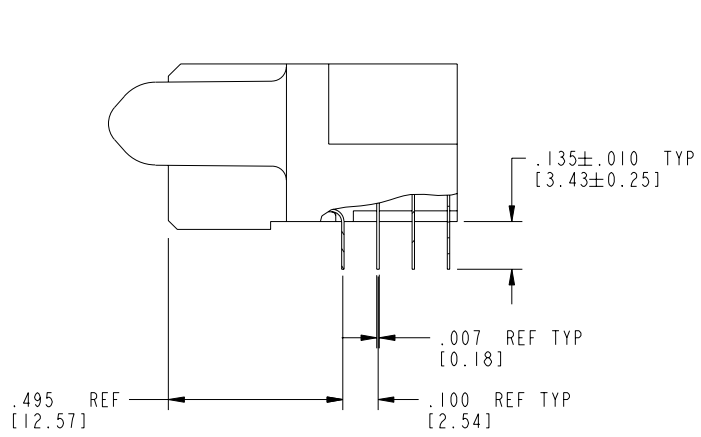

BROKEN-OUT SECTION A-A
SCALE 2:1

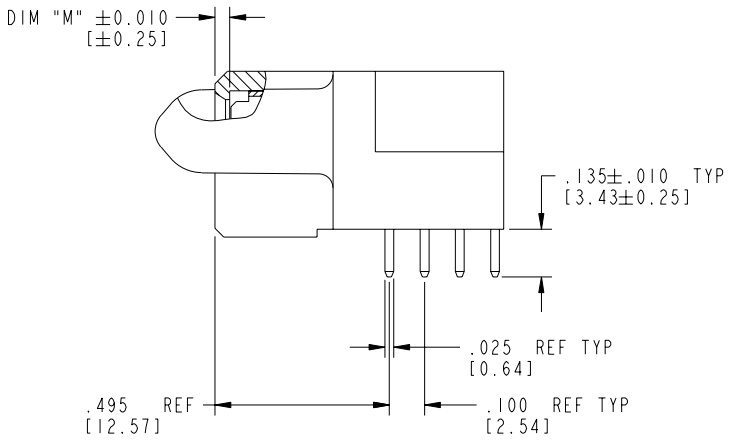

BROKEN-OUT SECTION B-B
SCALE 2:1

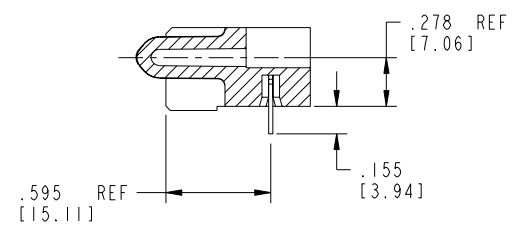

SECTION C-C

mat'l code		SEE NOTE 2		tolerances unless otherwise specified		CUSTOMER		 www.fciconnect.com	
ltr	ecn no.	dr	date	linear	.XX±.01/0.X±0.3	COPY		projection	title
C					.XXX±.005/0.XX±0.13				3ACP + 48S + 8P R/A SOLDER RECEPTACLE
				angles	.XXXX±.0020/0.XXX±0.051				product family
				dr	0°±2°			1:1	PwrBlade
				enrg	T. BRUNGARD 05/09/03			A	code
				chr	M. MOSTOLLER 05/09/03			size	213
				appd	M. MOSTOLLER 05/09/03			scale	sheet
								1:1	2 of 4
sheet index	revision sheet								

cage code 22526

Pro/E

PDM: Rev:C

STATUS: Released

Printed: Aug 15, 2007

Tous droits strictement réservés. Reproduction ou communication à des tiers interdite sous quelque forme que ce soit sans autorisation écrite du propriétaire. Propriété de c FCI. Droits de reproduction FCI.

All rights strictly reserved. Reproduction or issue to third parties in any form whatever is not permitted without written authority from the proprietor. Property of FCI. Copyright FCI.

PRODUCT NUMBER
51915-026__
NOTE: 3

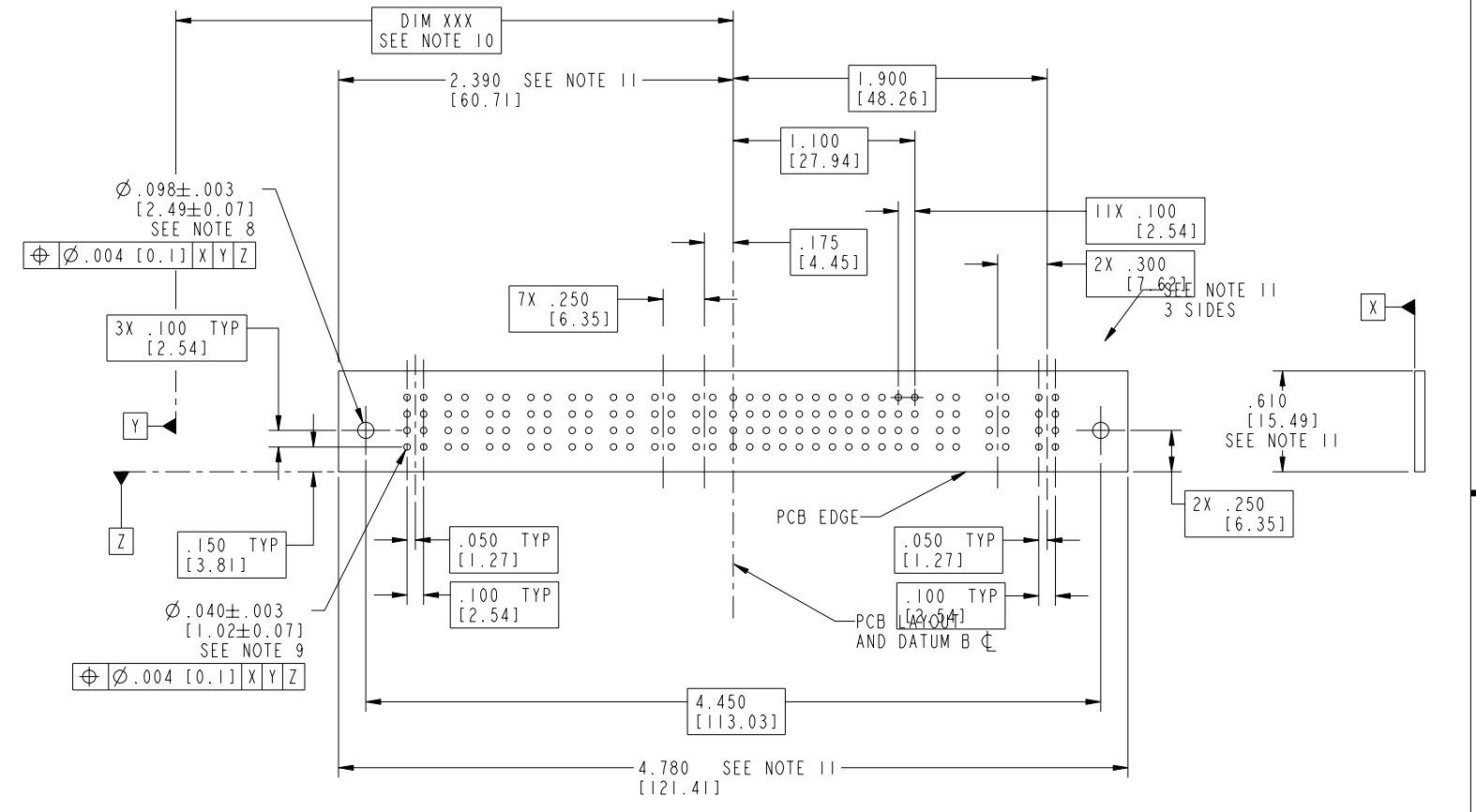

mat'l code		SEE NOTE 2		tolerances unless otherwise specified		CUSTOMER		 www.fciconnect.com	
ltr	ecn no.	dr	date	linear	.XX±.01/0.X±0.3	COPY		projection	title
C					.XXX±.005/0.XX±0.13				3ACP + 48S + 8P R/A SOLDER RECEPTACLE
				angles	.XXXX±.0020/0.XXX±0.051				product family
				dr	0°±2°			INCH/MM	PwrBlade
				enrg	T. BRUNGARD 05/09/03			scale	code
				chr	M. MOSTOLLER 05/09/03			1:1	213
				appd	M. MOSTOLLER 05/09/03			A	sheet
sheet index	revision sheet								3 of 4

cage code 22526 4

Tous droits strictement réservés. Reproduction ou communication à des tiers interdite sous quelque forme que ce soit sans autorisation écrite du propriétaire. Propriété de c FCI. Droits de reproduction FCI.

All rights strictly reserved. Reproduction or issue to third parties in any form whatever is not permitted without written authority from the proprietor. Property of FCI. Copyright FCI.

1 | 2

3 |

4

PRODUCT NUMBER
51915-026_
NIOTE:3

NOTES:

1. DIMENSIONS AND TOLERANCES ARE IN ACCORDANCE WITH ASME Y14.5M, 1994 UNLESS OTHERWISE SPECIFIED.

CONNECTOR NOTES:

② HOUSING MATERIAL: UL 94 V-0 GLASS FILLED
HIGH-TEMP THERMOPLASTIC
POWER CONTACT MATERIAL: COPPER ALLOY
SIGNAL PIN MATERIAL: COPPER ALLOY

3. PLATING:

51915-026 Singal Pin: 30u"/0.76um Au OVER 50u"/1.27um Ni ON THE CONTACT AREA,
AND 100u"/2.54um SnPb PLATING OVER 50u"/1.27um Ni ON THE TERMINATION SECTION.
Power Pin: 30u"/0.76um Au OVER 50u"/1.27um Ni ON THE CONTACT AREA,
AND 100u"/2.54um SnPb PLATING OVER 50u"/1.27um Ni ON THE TERMINATION SECTION.

51915-026LF Singal Pin: 30u"/0.76um Au OVER 50u"/1.27um Ni ON THE CONTACT AREA,
AND 78u"/2.00um Sn PLATING OVER 50u"/1.27um Ni ON THE TERMINATION SECTION.
Power Pin: 30u"/0.76um Au OVER 50u"/1.27um Ni ON THE CONTACT AREA,
AND 78u"/2.00um Sn PLATING OVER 50u"/1.27um Ni ON THE TERMINATION SECTION.

PART NUMBER 51915-026LF MEETS EUROPEAN UNION DIRECTIVE AND OTHER COUNTRY REGULATIONS AS DESCRIBED IN GS-22-008.

THE HOUSING WILL WITHSTAND EXPOSURE TO 260° PEAK TEMPERATURE FOR 10 SECONDS IN A WAVE SOLDER APPLICATION WITH A CIRCUIT BOARD.

④ MANUFACTURER'S NAME, P/N, AND DATE CODE TO APPEAR ON THIS SURFACE.

5. PRODUCT SPECIFICATION GS-12-149.
APPLICATION SPECIFICATION BUS-20-067.

6. PACKAGED IN TRAYS.

PCB NOTES:



7. ALL HOLE DIAMETERS ARE FINISHED HOLE SIZE.

⑧ MOUNTING HOLES, WHERE APPLICABLE, ARE UNPLATED.

⑨ $\varnothing .0453 \pm .0010$ [1.151 ± 0.025] DRILLED HOLES PLATED WITH
.0003 [0.008] MIN SnPb OVER .001 [0.03]
TO .003 [0.08] Cu PLATING TO ACHIEVE
 $\varnothing .040 \pm .003$ [1.02 ± .07] HOLE.

⑩ "DIM XXX" TO BE DETERMINED BY THE CUSTOMER.

⑪ CONNECTOR KEEP-OUT ZONE.

mat'l code				SEE NOTE 2		tolerances unless otherwise specified		CUSTOMER		 www.fciconnect.com	
ltr	ecr no.	dr	date	linear	.XX±.01/0.X±0.3	COPY		projection		title	
C					.XXX±.005/0.XX±0.13					3ACP + 48S + 8P R/A SOLDER RECEPTACLE	
				angles	.XXX±.0020/0.XXX±0.051			INCH/MM		product family	
				dr	0° ± 2°	T. BRUNGARD 05/09/03		scale		PwrBlade	
				enr		M. MOSTOLLER 05/09/03		1:1		code	
				chr		M. MOSTOLLER 05/09/03		A		213	
				appd		M. MOSTOLLER 05/09/03		51915-026		sheet	
sheet index		revision sheet								4 of 4	

A

A

B

B

1 | 2

3 |

cage code 22526

4

Pro/E

PDM: Rev:C

STATUS: Released

Printed: Aug 15, 2007